



Technical Data Sheet

Silicon Planar PIN Photodiode

PD70-01B/TR7



Features

- Daylight filter
- High sensitivity
- Low capacitance
- Short switching time
- Wide temperature range
- Small package
- Pb free
- The product itself will remain within RoHS compliant version.

Descriptions

- The PD70-01B/TR7 is high sensitivity, fast switching times, low capacitance, compact size, and lack of measurable degradation make it suitable for diverse applications, such as TV and appliance remote control, IR sound transmission, video recorders, and measurement and control.

Applications

- High speed photo detector
- Copier
- Elevator

Device Selection Guide

LED Part No.	Chip	Lens Color
	Material	
PD	Silicon	Black

Package Dimensions

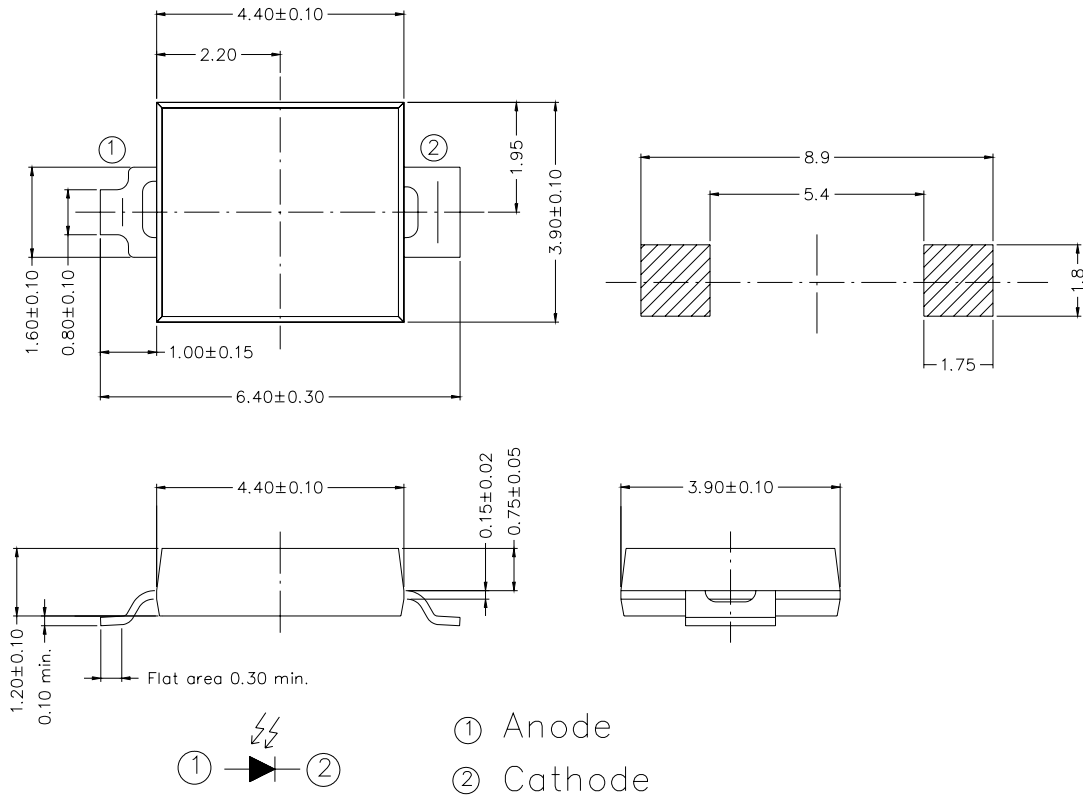

- Notes:** 1.All dimensions are in millimeters
2.Tolerances unless dimensions ± 0.1 mm

Absolute Maximum Ratings (Ta=25°C)

Parameter	Symbol	Rating	Units
Reverse Voltage	V_R	32	V
Operating Temperature	T_{opr}	-25 ~ +85	°C
Storage Temperature	T_{stg}	-40 ~ +85	°C
Soldering Temperature	T_{sol}	260	°C
Power Dissipation at(or below) 25°C Free Air Temperature	P_c	150	mW

Notes: *1: Soldering time ≤ 5 seconds

Electro-Optical Characteristics (Ta=25°C)

Parameter	Symbol	Condition	Min	Typ	Max	Unit
Rang Of Spectral Bandwidth	$\lambda_{0.5}$	---	730	---	1100	nm
Wavelength Of Peak Sensitivity	λ_p	---	---	940	---	nm
Open-Circuit Voltage	V_{OC}	Ee=5mW/cm ² $\lambda_p=940\text{nm}$	---	0.35	---	V
Short- Circuit Current	I_{SC}	Ee=1mW/cm ² $\lambda_p=940\text{nm}$	---	35	---	μA
Reverse Light Current	I_L	Ee=1mW/cm ² $\lambda_p=870\text{nm}$ $V_R=5\text{V}$	17	25	---	μA
Reverse Dark Current	I_D	Ee=0mW/cm ² $V_R=10\text{V}$	---	5	30	nA
Reverse Breakdown Voltage	B_{VR}	Ee=0mW/cm ² $I_R=100\mu\text{A}$	32	170	---	V
Total Capacitance	C_t	Ee=0mW/cm ² $V_R=3\text{V}$ $f=1\text{MHz}$	---	25	---	pF
Rise/Fall Time	t_r/t_f	$V_R=10\text{V}$ $R_L=1\text{K}\Omega$	---	50/50	---	nS

Typical Electro-Optical Characteristics Curves

Fig.1 Power Dissipation vs. Ambient Temperature

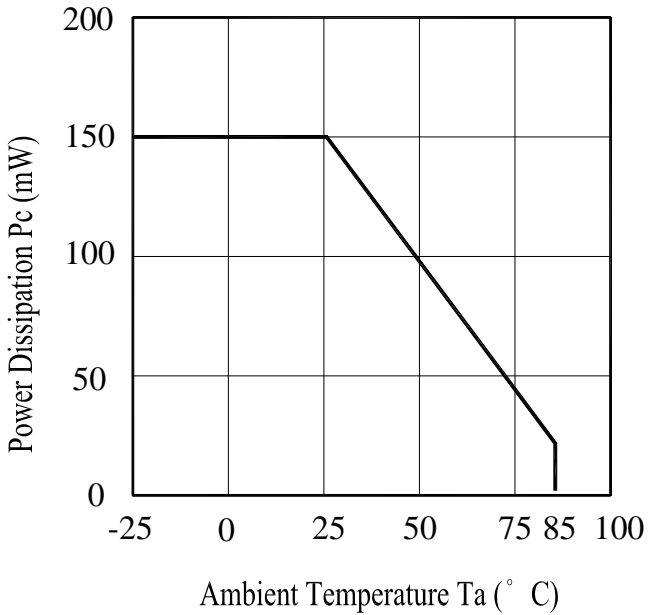

Fig.2 Spectral Sensitivity

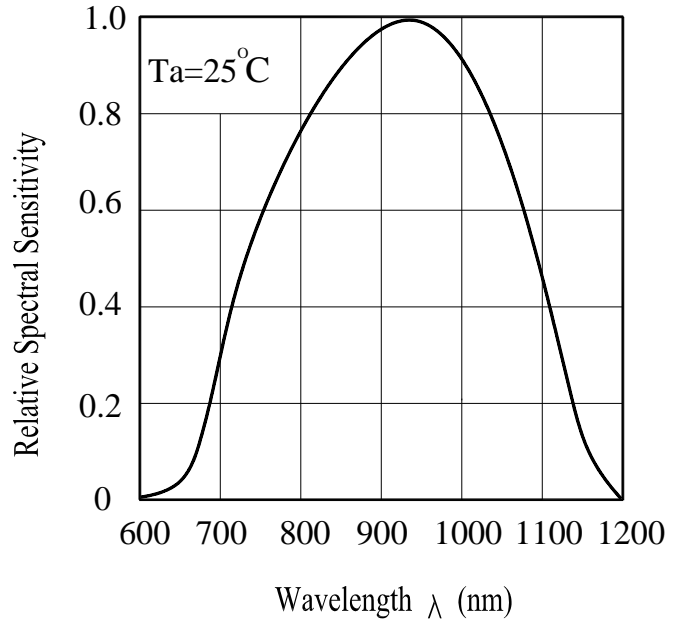

Fig.3 Dark Current vs. Ambient Temperature

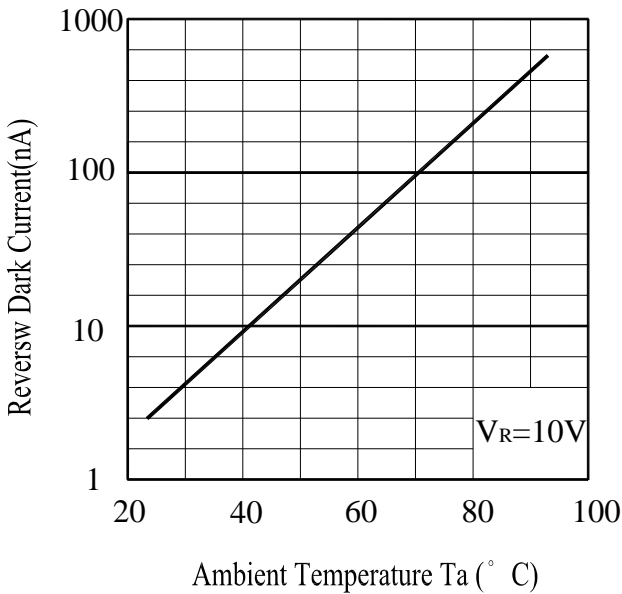
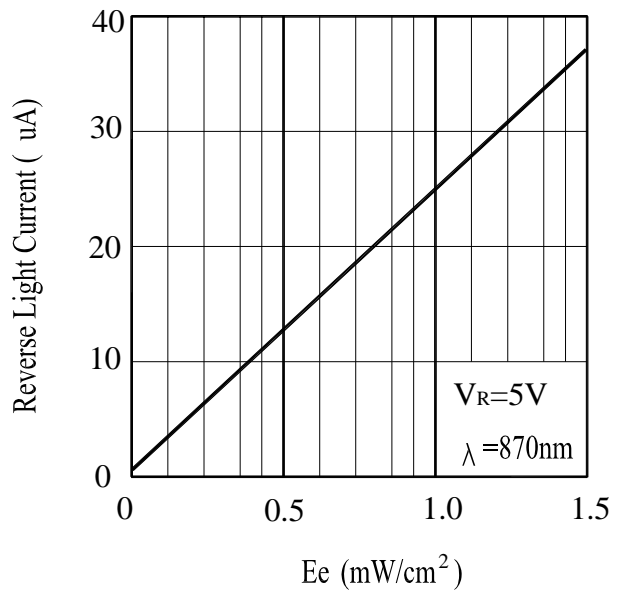

Fig. 4 Reverse Light Current vs. Ee



Typical Electro-Optical Characteristics Curves

Fig.5 Terminal Capacitance vs. Reverse Voltage

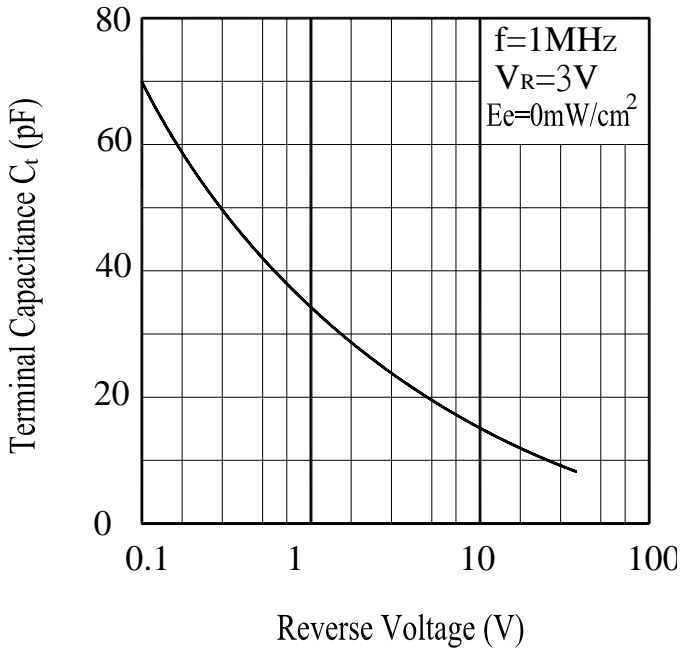
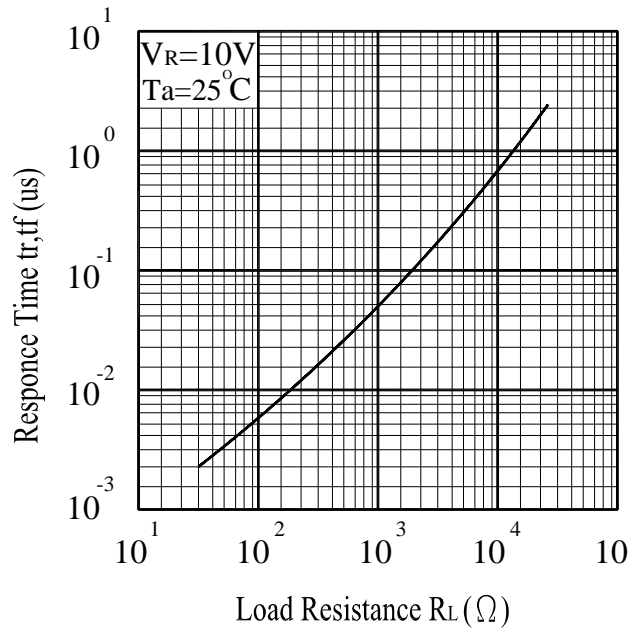

Fig.6 Response Time vs. Load Resistance



Precautions For Use

1. Over-current-proof

Customer must apply resistors for protection , otherwise slight voltage shift will cause big current change (Burn out will happen).

2. Storage

2.1 Do not open moisture proof bag before the products are ready to use.

2.2 Before opening the package, the LEDs should be kept at 30°C or less and 90%RH or less.

2.3 The LEDs should be used within a year.

2.4 After opening the package, the LEDs should be kept at 30°C or less and 70%RH or less.

2.5 The LEDs should be used within 168 hours (7 days) after opening the package.

2.6 If the moisture absorbent material (silica gel) has faded away or the LEDs have exceeded the storage time, baking treatment should be performed using the following conditions.

Baking treatment : 60±5°C for 24 hours.

3. Soldering Condition

3.1 Pb-free solder temperature profile

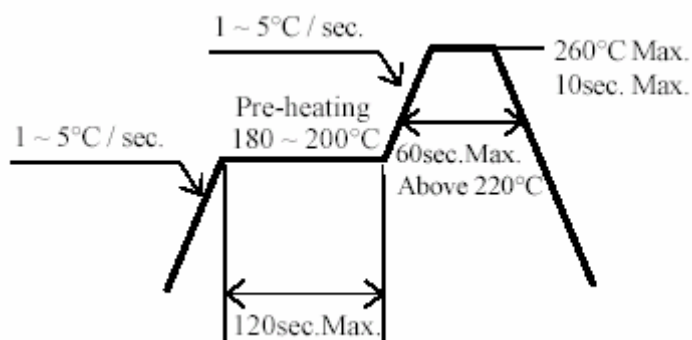

3.2 Reflow soldering should not be done more than two times.

3.3 When soldering, do not put stress on the LEDs during heating.

3.4 After soldering, do not warp the circuit board.

4.Soldering Iron

Each terminal is to go to the tip of soldering iron temperature less than 280°C for 3 seconds within once in less than the soldering iron capacity 25W. Leave two seconds and more intervals, and do soldering of each terminal. Be careful because the damage of the product is often started at the time of the hand solder.

5.Repairing

Repair should not be done after the LEDs have been soldered. When repairing is unavoidable, a double-head soldering iron should be used (as below figure). It should be confirmed beforehand whether the characteristics of the LEDs will or will not be damaged by repairing.

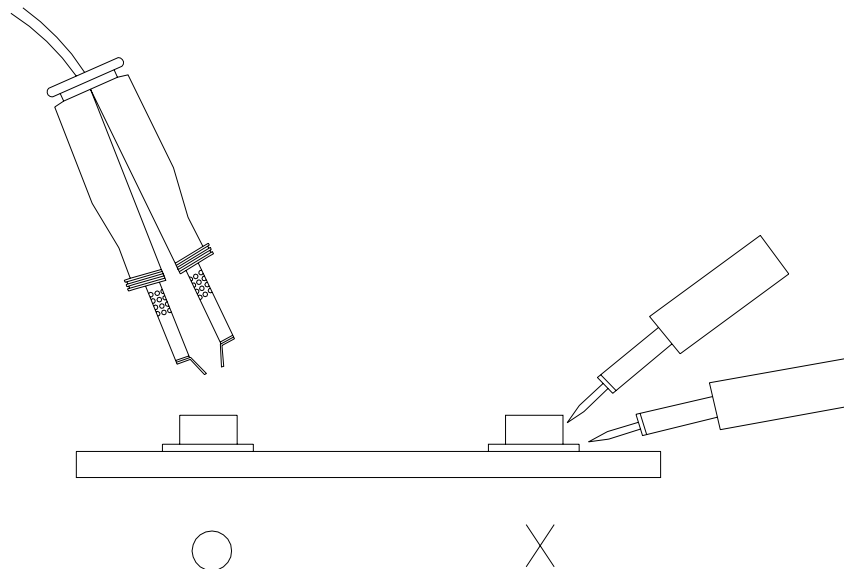

Reliability Test Item And Condition

The reliability of products shall be satisfied with items listed below.

Confidence level : 90%

LTPD : 10%

NO.	Item	Test Conditions	Test Hours/ Cycles	Sample Sizes	Failure Judgement Criteria	Ac/Re
1	REFLOW	TEMP. : 260°C±5°C 5secs	6Mins	22pcs		0/1
2	Temperature Cycle	H : 100°C 15mins ↑ 5mins ↓ L : -40°C 15mins	50Cycles	22pcs	$I_L \leq L \times 0.8$ L : Lower	0/1
3	Thermal Shock	H : +100°C 5mins ↑ 10secs ↓ L : -10°C 5mins	50Cycles	22pcs	Specification Limit	0/1
4	High Temperature Storage	TEMP. : +100°C	1000hrs	22pcs		0/1
5	Low Temperature Storage	TEMP. : -40°C	1000hrs	22pcs		0/1
6	DC Operating Life	$V_R=5V$	1000hrs	22pcs		0/1
7	High Temperature/ High Humidity	85°C / 85% R.H	1000hrs	22pcs		0/1

Package Dimensions

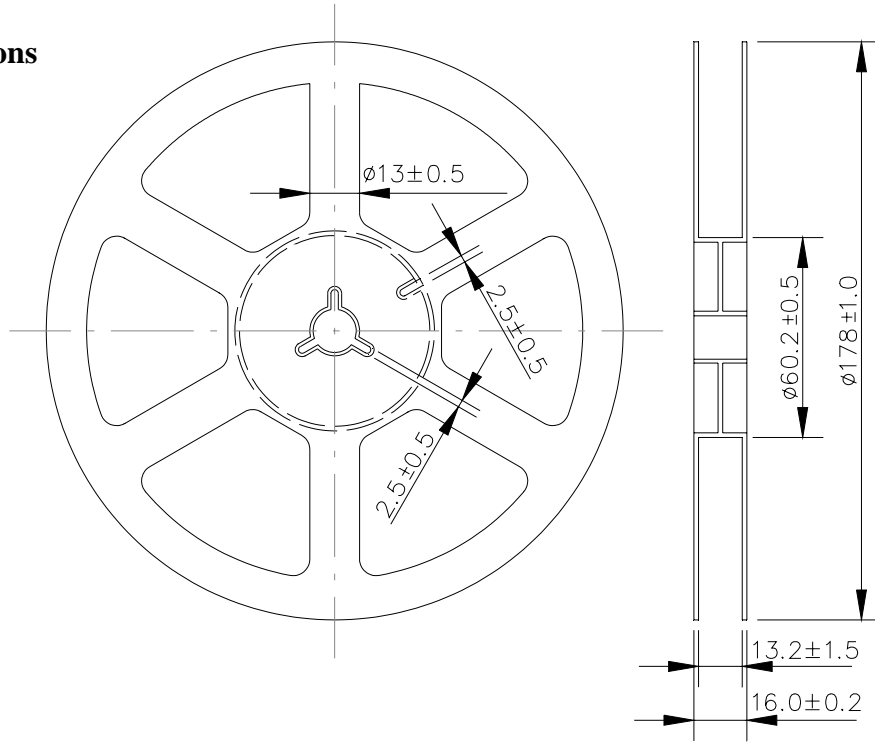

Loaded Quantity Per Reel 1000PCS/Reel

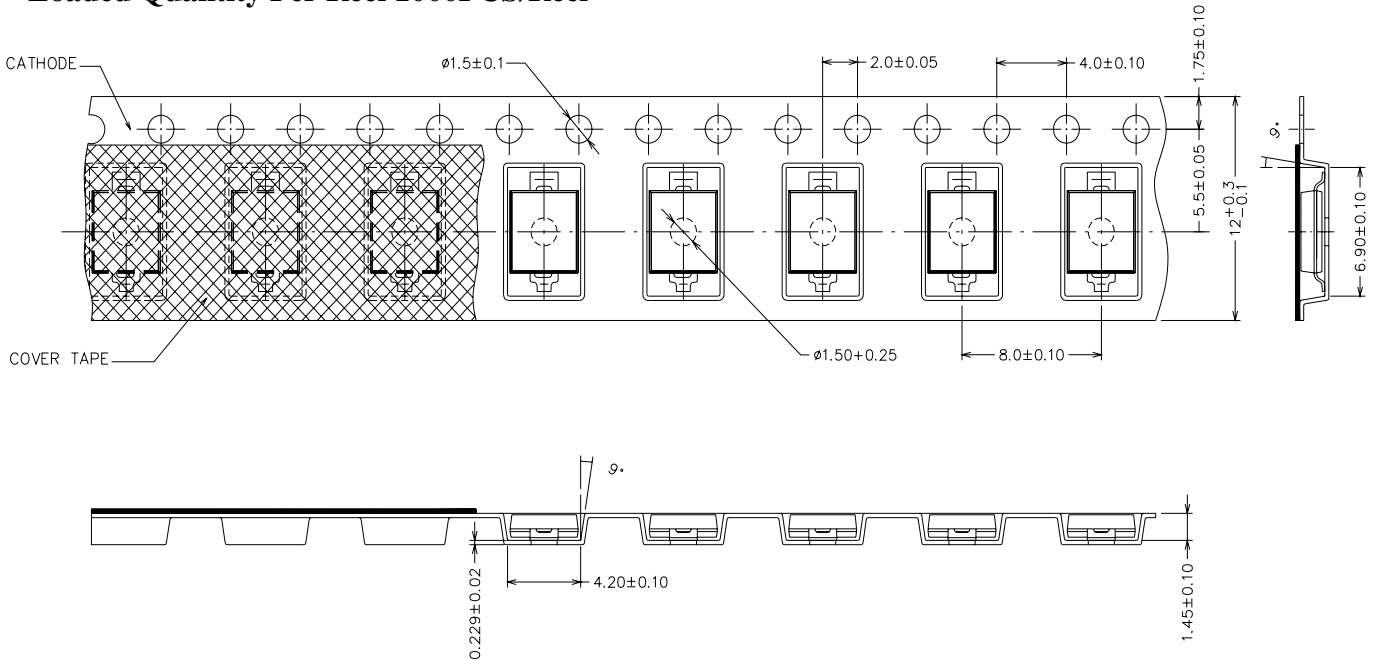

Unit :mm



Packing Quantity Specification

- 1.1000Pcs/1Volume , 1Volume/1Bag
- 2.10Boxes/1Carton

Label Form Specification

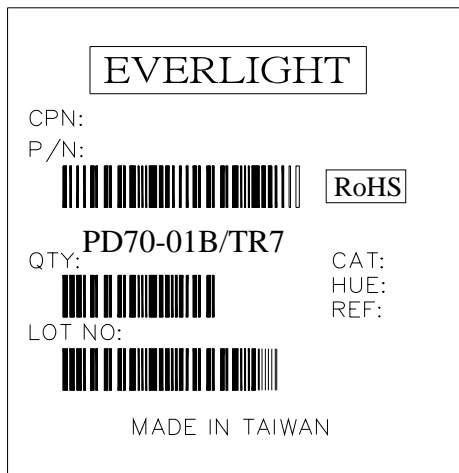

- CPN: Customer's Production Number
- P/N : Production Number
- QTY: Packing Quantity
- CAT: Ranks
- HUE: Peak Wavelength
- REF: Reference
- LOT No: Lot Number
- MADE IN TAIWAN: Production Place

Notes

1. Above specification may be changed without notice. EVERLIGHT will reserve authority on material change for above specification.
2. When using this product, please observe the absolute maximum ratings and the instructions for using outlined in these specification sheets. EVERLIGHT assumes no responsibility for any damage resulting from use of the product which does not comply with the absolute maximum ratings and the instructions included in these specification sheets.
3. These specification sheets include materials protected under copyright of EVERLIGHT corporation. Please don't reproduce or cause anyone to reproduce them without EVERLIGHT's consent.

EVERLIGHT ELECTRONICS CO., LTD.
Office: No 25, Lane 76, Sec 3, Chung Yang Rd,
Tucheng, Taipei 236, Taiwan, R.O.C

Tel: 886-2-2267-2000, 2267-9936
Fax: 886-2267-6244, 2267-6189, 2267-6306
<http://www.everlight.com>