

## FEATURES

- Low ESR and High Ripple Current Ratings
- Values from 10 $\mu$ F to 470 $\mu$ F
- Suitable for Flow and Reflow Soldering Processes
- Available in EIA B, C and D Case Sizes

## RoHS Compliant

includes all homogeneous materials

\*See Part Number System for Details

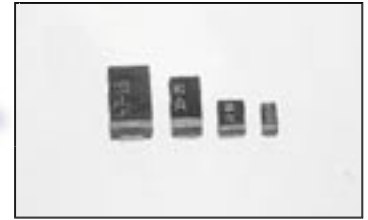

## SPECIFICATIONS

Capacitance Range	10 $\mu$ F to 470 $\mu$ F		
Capacitance Tolerance	+20% (M), +10% (K)		
Rated Working Voltage	6.3Vdc to 35Vdc		
Operating Temperature Range	-55°C ~ +125°C (derating above 85°C)		
Dissipation Factor @120Hz/25°C	10 $\mu$ F-68 $\mu$ F 6% max.	100 $\mu$ F-150 $\mu$ F 8% max.	220 $\mu$ F-470 $\mu$ F 10% max.*
Capacitance Change Verse Temperature	-55°C	+85°C	+125°C
	$\Delta$ C - 10%	$\Delta$ C + 10%	$\Delta$ C + 12%
Soldering Heat Resistance (+260°C for 5 ~ 10 sec.)	$\Delta$ C + 10% Max., Leakage Current and Dissipation Factor will be less than value specified below		
Moisture Resistance (500 hours; 90~95% RH @40°C)			
Load Life Test (at rated voltage) (2000 hours @ 85°C)			
Base Failure Rate (1.0 $\Omega$ /Volt)	1%/1000 hours at 60% confidence level (+85°C)		

## PART NUMBER SYSTEM

NTC-L 106 K 16 TR B F

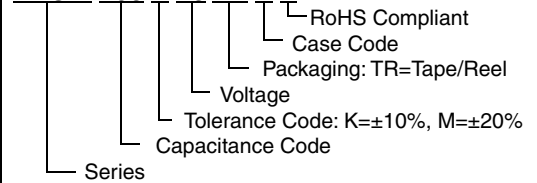

## STANDARD RATINGS AND CASE SIZE

Rated Voltage @85°C	6.3Vdc	10Vdc	16Vdc	20Vdc	25Vdc	35Vdc
Surge Voltage @85°C	8	13	20	26	32	45
Derated Voltage @125°C	4	6.3	10	13	16	22
Capacitance ( $\mu$ F)	Code	Case Size	Case Size	Case Size	Case Size	Case Size
10	106	B	B	B	C	D
15	156	B	B	C	C	D
22	226	B	C	C	D	D
33	336	C	C	D	D	D
47	476	C	D	D	D	-
68	686	D	D	D	-	-
100	107	D	D	D	-	-
150	157	D	D	-	-	-
220	227	D	D	-	-	-
330	337	D	D (*18%)	-	-	-
470	477	D (*18%)				

## MAXIMUM ESR (ohms) @ 25°C/100Khz

Capacitance ( $\mu$ F)	6.3Vdc	10Vdc	16Vdc	20Vdc	25Vdc	35Vdc
10	0.70	0.70	0.6	0.60	0.30	0.30
15	0.60	0.60	0.5	0.50	0.30	0.30
22	0.50	0.50	0.4	0.35	0.30	0.50
33	0.35	0.35	0.25	0.30	0.30	-
47	0.35	0.25	0.20	0.20	-	-
68	0.20	0.20	0.15	-	-	-
100	0.15	0.10	0.10	-	-	-
150	0.10	0.10	-	-	-	-
220	0.10	0.10	-	-	-	-
330	0.10	0.20	-	-	-	-
470	0.20	-	-	-	-	-

## MAXIMUM RIPPLE CURRENT @ 25°C (mA) @100Khz

Capacitance ( $\mu$ F)	6.3Vdc	10Vdc	16Vdc	20Vdc	25Vdc	35Vdc
10	370	370	400	400	630	630
15	400	400	440	440	630	630
22	440	440	500	580	630	490
33	530	530	690	630	640	-
47	530	690	770	830	-	-
68	770	770	890	-	-	-
100	890	1,100	1,100	-	-	-
150	1,100	1,100	-	-	-	-
220	1,100	1,100	-	-	-	-
330	1,100	770	-	-	-	-
470	770	-	-	-	-	-

## PRECAUTIONS

Please review the notes on correct use, safety and precautions found on pages T10 & T11 of NIC's Electrolytic Capacitor catalog.  
Also found at [www.niccomp.com/precautions](http://www.niccomp.com/precautions)  
If in doubt or uncertainty, please review your specific application - process details with NIC's technical support personnel: [tpmg@niccomp.com](mailto:tpmg@niccomp.com)



## MAXIMUM LEAKAGE CURRENT @25°C (µA)

Capacitance (µF)	6.3Vdc	10Vdc	16Vdc	20Vdc	25Vdc	35Vdc
10	0.7	1.0	1.6	2.0	2.5	3.5
15	1.0	1.5	2.4	3.0	3.8	5.3
22	1.4	2.2	3.5	4.4	5.5	7.7
33	2.1	3.3	5.3	6.6	8.3	-
47	3.0	4.7	7.5	9.4	-	-
68	4.3	6.8	11	-	-	-
100	6.3	10	16	-	-	-
150	9.5	15	-	-	-	-
220	14	22	-	-	-	-
330	20.8	33	-	-	-	-
470	32.9	-	-	-	-	-

## CASE DIMENSIONS (mm)

Case Code	L ±0.2	W ±0.2	H ±0.2	l <sub>1</sub> ±0.2	l <sub>2</sub> ±0.2	a ±0.2	b ±0.2	c ±0.1
B	3.4	2.6	1.9	1.4	0.8	2.0	0.7	2.2
C	5.8	3.2	2.5	2.4	1.3	2.2	0.7	2.4
D	7.3	4.3 ±0.3	2.8	3.8	1.3	2.4	1.2	3.3

## TAPING SPECIFICATIONS (mm)

Case Size	A ±0.1	B ±0.1	C ±0.3	D ±0.1	E ±0.1	F ±0.1	G ±0.1	H ±0.1	J ±0.1	K max.	t max.	Reel Qty
B	3.1	3.9	8.0	3.5	1.75	4.0	2.0	4.0	1.5	2.5	0.2	2000
C	3.7	6.3	12.0	5.5	1.75	8.0	2.0	4.0	1.5	3.0	0.3	500
D	4.8	7.7	12.0	5.5	1.75	8.0	2.0	4.0	1.5	3.4	0.3	500

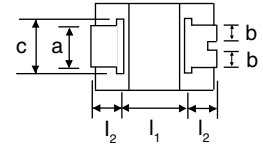
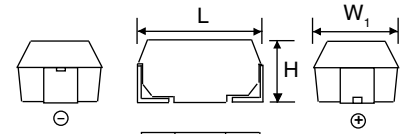

B and C Case Size

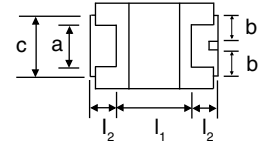
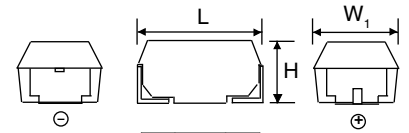

D Case Size

Terminations:  
100% Sn (Lead-Free)  
Standard

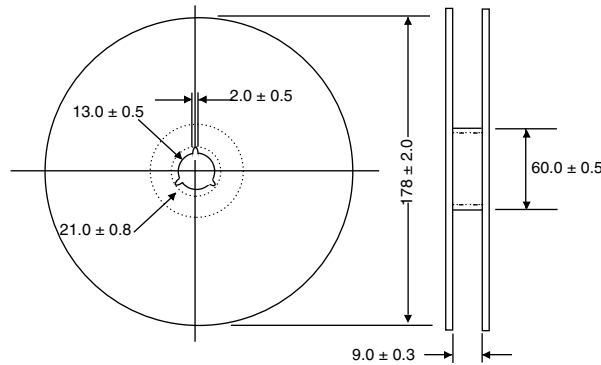

## RECOMMENDED SOLDERING PROFILES

Note: To avoid thermal shock a preheating stage, 130°C ~ 160°C for 1 minute, should be incorporated into the soldering process

Reflow Soldering - Permitted Temperature/Time Range

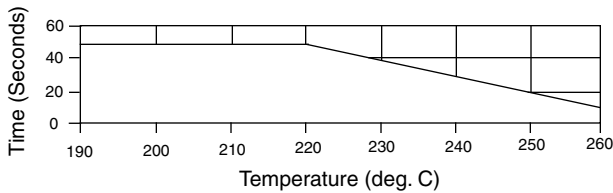

Flow Soldering - Permitted Temperature/Time Range

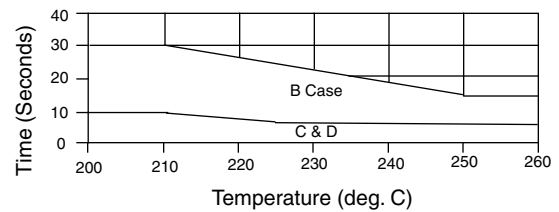

Reflow Soldering - Recommended Profile Maximum Temperature/Time: 260°C/10 Sec.

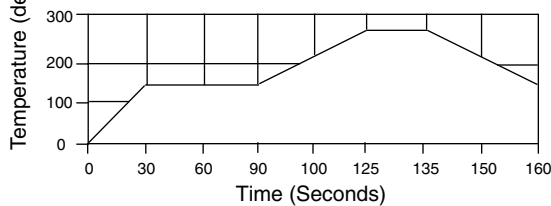

Flow Soldering - Recommended Profile Maximum Temperature/Time: 245°C/5 Sec.

